



CARDINAL STEELS

**UK ROOFING AND CLADDING
MANUFACTURER**

INFO

WHAT WE DO	1
WHAT WE OFFER	1
ABOUT	2

PRODUCTS

BOX PROFILE ROOF SHEETS	5
CORRUGATED ROOF SHEETS	9
ANTI CONDENSATION ROOF SHEETS	12
INSULATED ROOF SHEETS	13
GRP ROOF LIGHTS	15
Z PURLINS AND SECTIONS	17
FLASHINGS AND TRIMS	19
ACCESSORIES	21
REVIEWS	24
CONTACT US	25
FIND US	26



UK NATIONAL COVERAGE



HIGH QUALITY PRODUCTS



MANUFACTURER PRICES

**CARDINAL
STEELS**

WHAT WE DO





Cardinal Steels manufactures and supplies steel roofing sheets and roof cladding, with UK national coverage and delivery. We offer manufacturer prices on all products, which are produced to your specifications and requirements. We supply roofing sheets to the industrial, commercial, residential and agricultural sectors, with a friendly team of staff offering advice on our products.

QUALITY

HIGH QUALITY MATERIALS
MANUFACTURED TO ORDER

WHAT WE OFFER

Our metal roof sheets are available with:

-  Stock lengths or manufactured to order
-  A wide range of colours and finishes to suit your needs
-  Durable coatings with up to a 30 year guarantee
-  In-house transportation offering nationwide delivery
-  A one-stop solution for all metal roofing and steel cladding requirements

RANGE

WIDE RANGE OF THICKNESS',
COLOURS AND FINISHES

NATIONWIDE

NATIONWIDE IN HOUSE
TRANSPORT SERVICE
AVAILABLE

ABOUT

Cardinal Steels brings extensive experience in the UK roofing and cladding industry. We operate on two simple yet powerful principles: manufacture high-quality products and deliver them on time. These core values have helped us consistently grow our client base. Conveniently located just 10 minutes from Junction 1 of the M42 and 15 minutes from Junction 4 of the M5, we are based in the heart of Bromsgrove, Worcestershire.

At Cardinal Steels, no job is too small. Whether it's a garage or an industrial estate, we provide the same level of dedication and service. While some competitors may overlook smaller projects, we ensure that our service remains exceptional, no matter the job size.





MANUFACTURED TO LENGTH

Roofing sheets available up to 12m in length



QUALITY GUARANTEE

Coatings available with up to 30 years Guarantee



NATIONWIDE SERVICE

Nationwide delivery service to mainland UK.
48 Hour delivery on request (subject to availability)



**PROVEN
TRACK
RECORD**

"Easy to use website, ordering what I needed was simple. Fast delivery the driver kept me updated calling on morning of delivery to confirm and then just before arrival, driver was great helping me with putting the sheets in a safe place nice and friendly he went above and beyond. Great company would highly recommend."

BOB BABER

Check out more of our latest reviews on page 24



BOX PROFILE ROOFING SHEETS

Box Profiles & Coatings

Cardinal Steels provides box profile roofing sheets with a fast turnaround and delivery within 7 days. The 32/1000 trapezoidal roofing are available in a wide range of thicknesses and coatings, for example, galvanised, polyester and Plastisol.

This can be manufactured to any length, up to 12 meters. Furthermore, the box profiles give a fitted coverage of 1000mm (1m) after overlapping. For example, ten sheets will cover a ten-meter width.

Solid Trapezoidal Roofing Sheets

Our box profile sheets are the most popular choice within the cladding and roofing industries across all sectors. The CS 32/1000 is available with an anti-condensation backing, applied as a single skin sheet or twin skin in a built-up system.

What Is The Standard Thickness

The standard thickness for all Cardinal Steels' box profile sheets is 0.7mm. However, all are available in the 0.5mm option used for wall cladding and CS 32/1000 Liner Panel. Furthermore, they are simple to install and are easily maintained with minimum work. Please ask a member of staff for details for methods of maintenance.

THE RANGE OF COATINGS WE OFFER

We would always recommend Plastisol. Firstly, the product's finish has an excellent resistance to abrasion and corrosion. In addition, the polyester is a fantastic product, suitable for both our box profile and corrugated sheets, but can be liable to scratching even if not handled with care whilst unloading and fitting.

There are four coatings available. These are:

-  Galvanised - Shiny/Dull silver colour in finish. Available in 0.4mm up to 0.7mm thickness. No guarantee available.
-  Polyester - Gloss finish. Available in 0.4mm up to 0.7mm thickness. Up to 15 years guarantee.
-  Plastisol HP200 Leathergrain - Gloss finish. Available in 0.4mm up to 0.7mm thickness. Up to 25 years guarantee.
-  Plastisol HPS Ultra - Gloss finish. Available in 0.4mm up to 0.7mm thickness. Up to 30 years guarantee.

AVAILABLE COLOURS

Please be aware that these are colour representations to be used as a general guide and the physical colour may vary. Please get in touch with a member of our team if you would like a colour sample sent out to you.

WHITE



GOOSEWING GREY

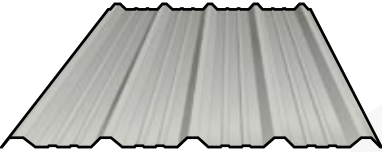

MEADOWLAND



ALBATROSS

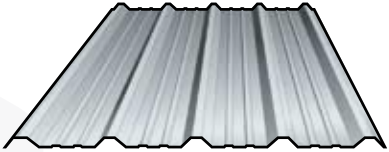

MERLIN GREY

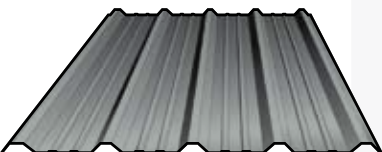

MOORLAND GREEN



WEDGEWOOD BLUE

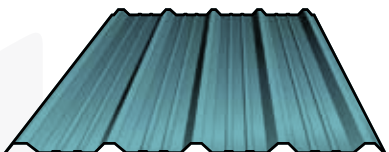

HERITAGE GREEN



OCEAN BLUE



ANTHRACITE



OLIVE GREEN



TERRACOTTA



SARGASSO



BLACK



JUNIPER GREEN



VANDYKE BROWN



BOX PROFILES

CS32/1000 BOX PROFILE - ROOF

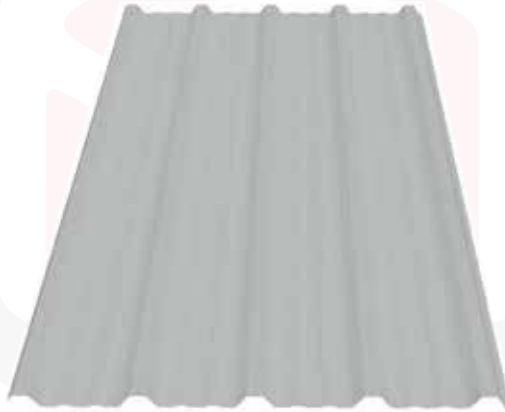
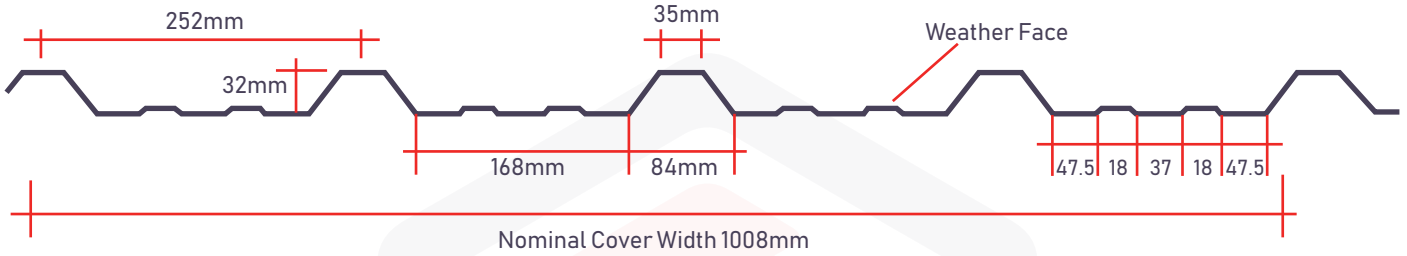

CS32/1000 BOX PROFILE - WALL

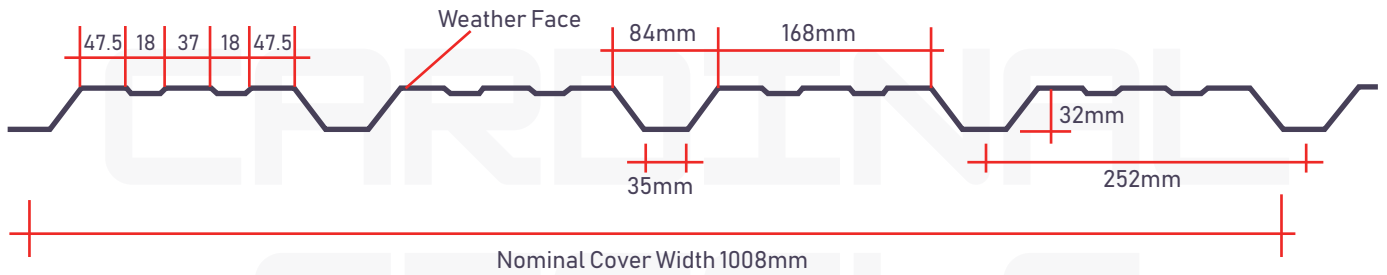

CS34/1000 BOX PROFILE - ROOF

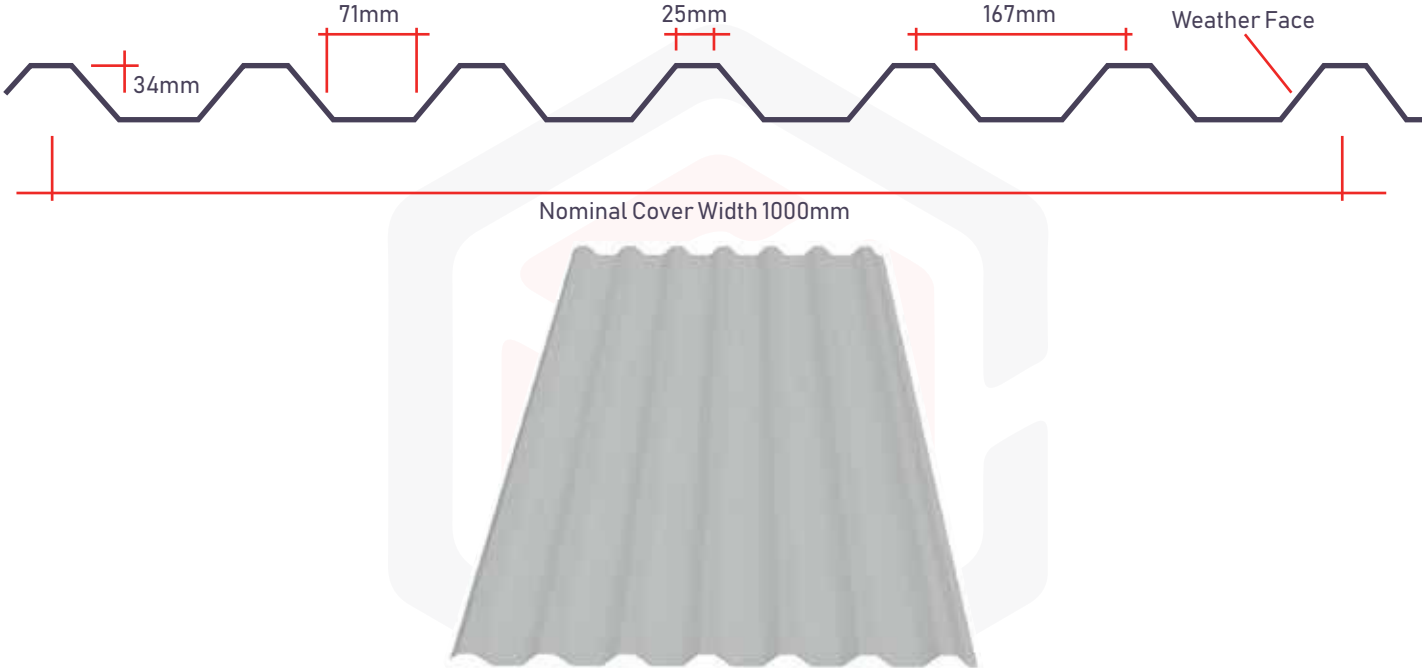

CS34/1000 BOX PROFILE - WALL

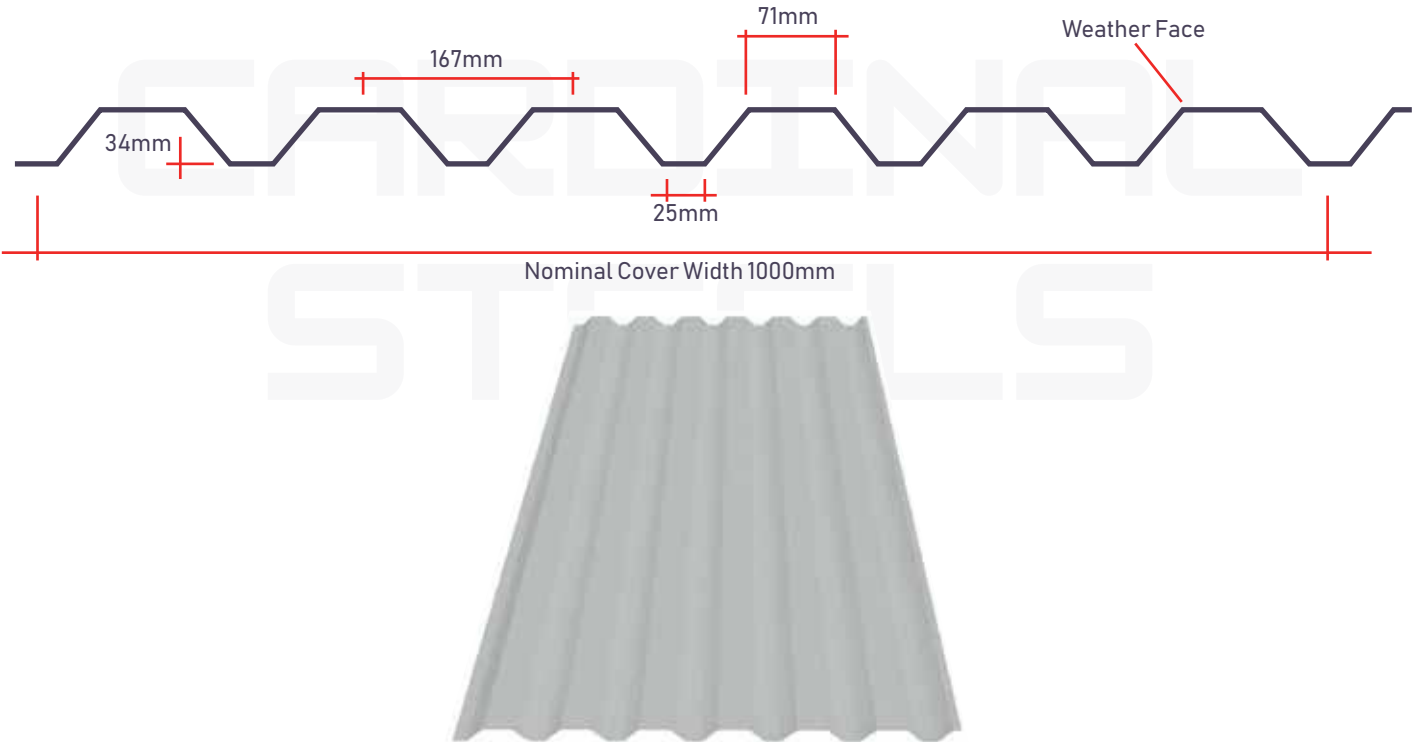

CORRUGATED ROOFING SHEETS

Cardinal Steels offers traditional 3" corrugated roofing panels up to 12 meters long. In addition, depending on the job and application, we can manufacture the corrugated galvanised sheets to different widths to meet your needs.

It is often the number one choice for use on new commercial, industrial, residential and agricultural projects as well as building renovations and restorations. Our high-quality product is practical, functional and aesthetically pleasing. For your convenience, we offer manufacturer prices with collection or shipping across the UK.

Our corrugated steel roofing sheets are straightforward to install and easy to maintain. Furthermore, we supply a wide range of accompanying flashing, trims, fixings, fillers and sealants to support installation from start to finish.

Corrugated Steel Roofing

Our steel corrugated curved sheets are available in 990mm cover width. The standard thickness of our galvanised roof sheets is 0.7mm, but they are also available with a thickness of 0.5mm, typically used for wall cladding.

CORRUGATED ROOFING FINISHES

Corrugated roofing is available in all finishes; however we would always recommend Plastisol due to having the best corrosion and abrasion resistance. Unlike a polyester finish, Plastisol does not scratch easily while carrying out simple handling tasks such as unloading and fitting. Depending on the finish, the durable coatings are offered with up to a 30 year guarantee, keeping your corrugated metal roof sheets in great shape for years.

As well as being used for roofing, our corrugated steel sheets are ideal for cladding the walls of your warehouse, office or factory.

There are four coatings available. These are:

-  Galvanised - Shiny/Dull silver colour in finish. Available in 0.4mm up to 0.7mm thickness. No guarantee available.
-  Polyester - Gloss finish. Available in 0.4mm up to 0.7mm thickness. Up to 15 years guarantee.
-  Plastisol HP200 Leathergrain - Gloss finish. Available in 0.4mm up to 0.7mm thickness. Up to 25 years guarantee.
-  Plastisol HPS Ultra - Gloss finish. Available in 0.4mm up to 0.7mm thickness. Up to 30 years guarantee.

AVAILABLE COLOURS

Please be aware that these are colour representations to be used as a general guide and the physical colour may vary. Please get in touch with a member of our team if you would like a colour sample sent out to you.

WHITE



GOOSEWING GREY



MEADOWLAND



ALBATROSS



MERLIN GREY

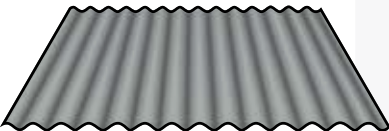

MOORLAND GREEN



WEDGEWOOD BLUE

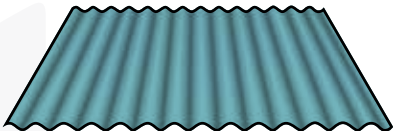

HERITAGE GREEN



OCEAN BLUE



ANTHRACITE



OLIVE GREEN



TERRACOTTA



SARGASSO



BLACK



JUNIPER GREEN



VANDYKE BROWN



CORRUGATED PROFILE

13.5 / 3 CORRUGATED

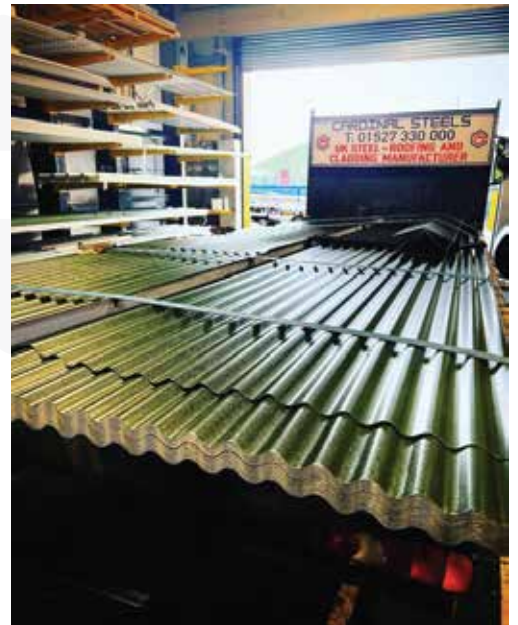
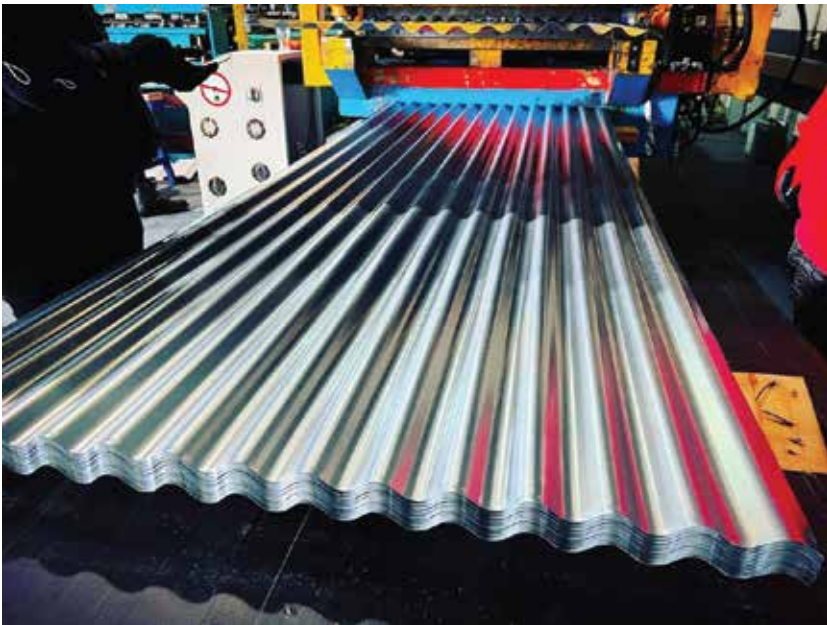
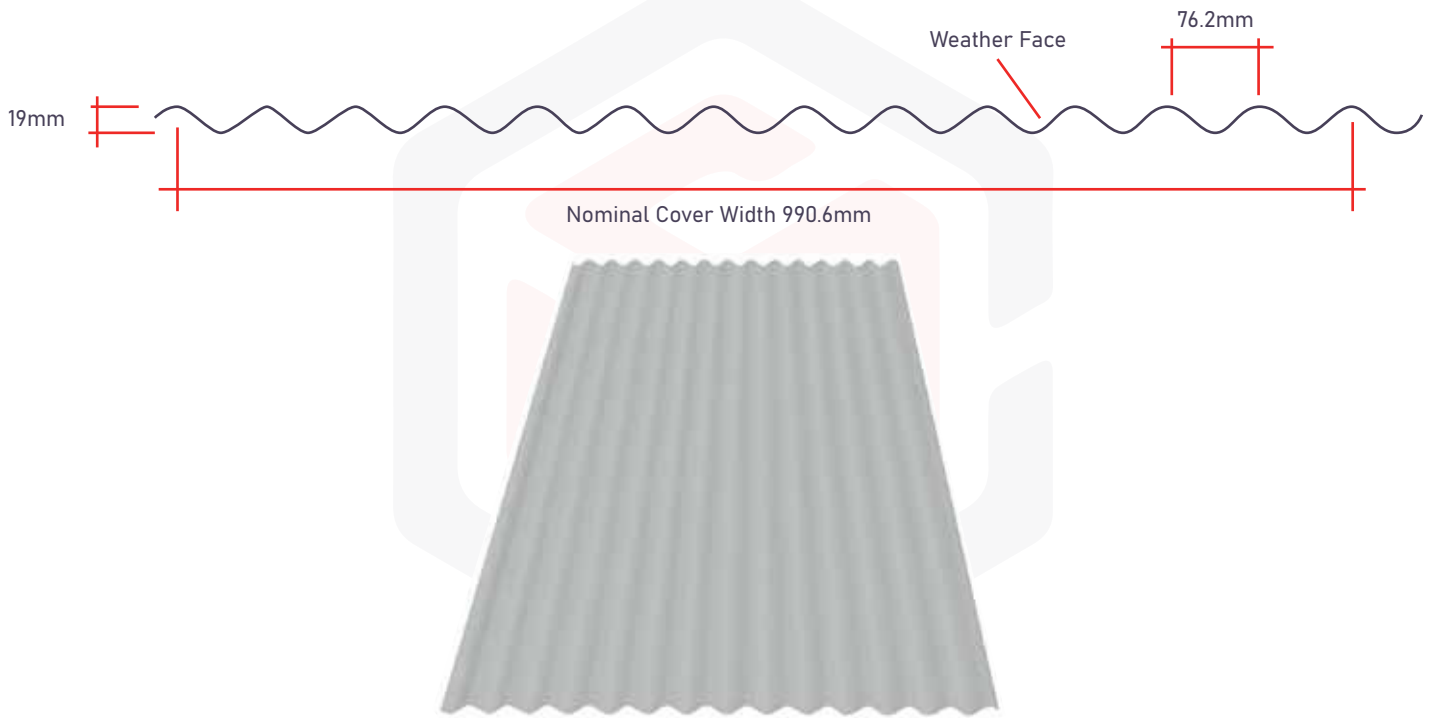

ANTI-CONDENSATION ROOFING

Cardinal Steels supplies high-quality roof sheets coated with an anti-condensation membrane to reduce damp and drips that can damage stock, equipment and machinery within a warehouse or factory environment. Anti-condensation roofing sheets are the best solution for almost any building where a single skin roofing system is to be installed.

Our Dripstop roof sheets are used in many different settings from storage facilities to garages, aircraft hangers, stables, kennels, shelters, industrial buildings and livestock buildings. Furthermore, we manufacture the anti-drip roofing sheets to your precise requirements, offering the perfect solution at an affordable price for small and large roofing projects.

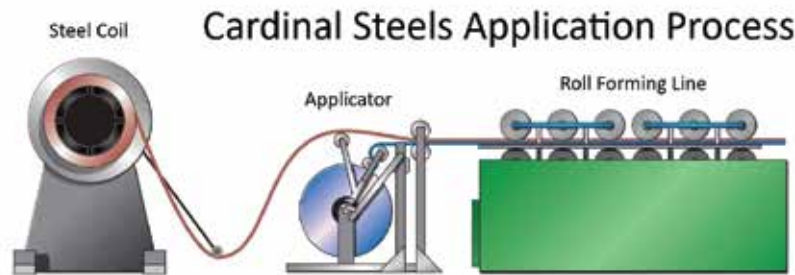

DRIPSTOP MEMBRANE

Box profile roofing sheets with Dripstop anti-condensation membrane are the most effective and cost-efficient way of preventing moisture build-up. Moisture condensing on the underside of uninsulated metal roofing is caused when the temperature and humidity conditions reach the dew point.

The Dripstop membrane on the underside of the roof sheets works by trapping moisture in specially formed pockets in the membrane. The moisture is kept in these pockets until conditions drop back past the dew point. As a result, the moisture is then slowly released back into the air. The process remains effective for the duration of its lifespan.

The self-adhesive membrane is applied through a roll forming line process. The Dripstop membrane is available with either Polyester or PVC Plastisol finished sheeting.

The material has high water absorption and is bacteria resistant. It can be cleaned, if necessary, with a hose or a high pressure jet washer and also offers additional acoustic insulation reducing noise created on the steel, such as heavy rainfall.

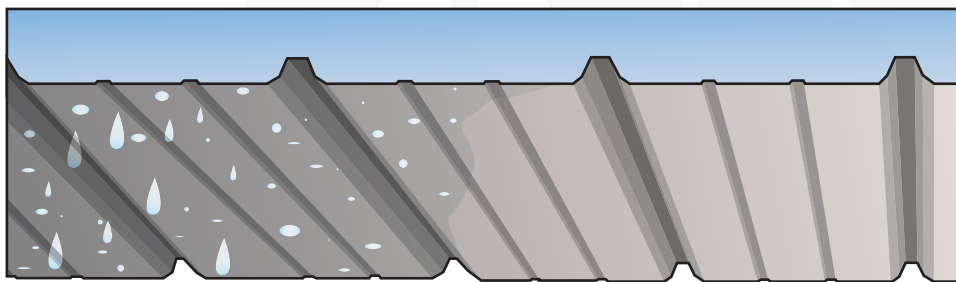

Anti-condensation roof sheets are a tried and tested product that is clean, efficient and practical. To enquire further about our steel roofing solutions or to place an order, please contact our team today.

Exclusions: Anti-condensation liner is not compatible with Galvanised finish or 34/1000 profiles.

INSULATED ROOFING

Insulation That Keeps You Comfortable & Saves Costs

Cardinal Steels offers three types of insulated roofing, including composite panels, twin skin and over-cladding. Therefore, these are ideal for new projects and renovations throughout the commercial, residential, industrial and agricultural sectors.

The insulated roofing sheets combine with the high-performing insulation, and as a result the interior space of any building retains more warmth. Furthermore, by reducing the amount of heat lost through the roof, it is possible to make worthwhile savings on your fuel bill or operational budget. For example, on hot days during the summer, the insulated roof panels works to keep heat out. Due to this, the space maintains a comfortable ambient temperature inside and reducing air conditioning costs.

Smart Coatings For Extra Protection

The smart coated finish provides excellent protection from snow and rain, and transforms exterior aesthetics. In addition, older buildings gain a modern and professional appearance, bringing them in line with new structures and the surrounding area.

We coat the top surface with Plastisol to give it the most durable finish, with greater resistance to scratching during unloading and fitting. To aid installation, we offer a wide range of fixings designed for different structures and materials. Further, we offer customer collection and nationwide delivery with manufacturer prices, giving you or your business a fantastic deal.

INSULATED ROOFING MADE FOR PURPOSE

Composite Panels

These insulated composite panels have fantastic thermal performance and fire rating. Therefore, like all steel roofing products, you enjoy a low-maintenance system. Cardinal's composite panels have a straightforward lapping detail. The insulate composite is slightly heavier, consequently, giving extra durability that proves very popular with most cladding contractors. All sheets are manufactured to length and are available in our full range of colours. The under sheet is a bright white steel internal liner. Additional colours are available but may delay lead time. In between the two steel skins is an insulated core available in several thicknesses dependent on the U-value that is required for the building. Composite panels can be manufactured up to 15,000mm in length or cut back to customer specifications.

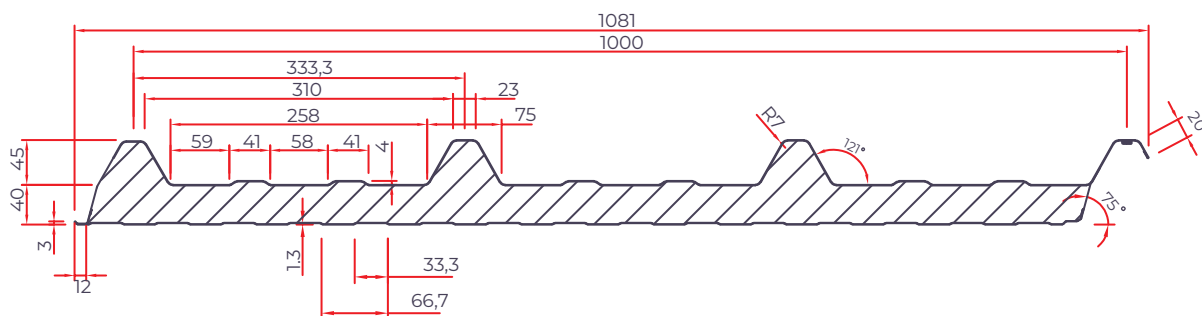



The standard thicknesses are 40mm / 60mm / 80mm / 100mm / 120mm / 150mm. Please speak to a member of staff for lead times.

For available colours please see page 6

Twin Skin / Built-up System

This system is an amazingly simple and cost-effective way of creating an insulated roof panels. They are made up of several components; white liner inner sheet, spacer bar / mini zed purlin, insulation and a box profile 0.7mm outer sheet. Depending on the U-value you require, the depth of the spacer bar and thickness of the insulation can be altered. Like the composite panels, you can choose the colour of your outer sheet, while the inner sheet is usually a white gloss finish. The lead time on this product is normally short and the money saved on materials warrants purchasing this product. Some contractors prefer this method due to less heavy lifting compared to using composite panels.

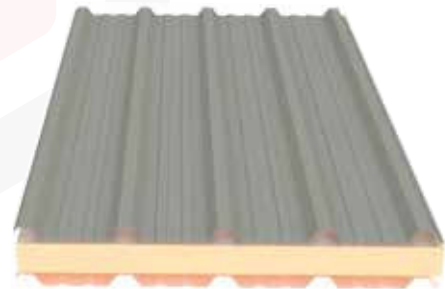
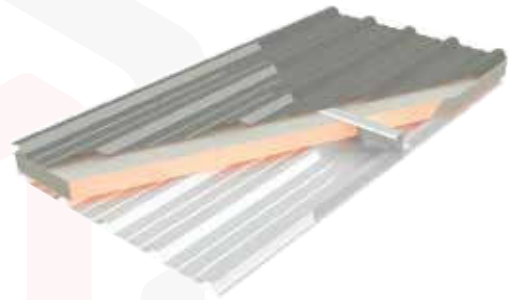

Over Cladding

This method is typically the most cost-effective way of insulating a building as it allows you to utilise the existing panels rather than starting from new. To install over cladding, you will first need to batten the roof with steel or timber (this is normally 3 x 2). The battens are fixed down through the existing panels into the purlins / beams. Once this is completed then the insulation is laid. Lastly, the top sheet, which is available in a colour of your choice, is then fixed down to the battens or rails. This saves costs all round as you use the existing sheeting and as a result removes the cost of stripping and disposing of the used materials, which you may face with the other methods. Furthermore, over cladding can be used simply to improve the look of an aged building by providing a more modern and updated look and feel.

Bar & Bracket

The bar and bracket system can be used as an alternative to Mini Z spacer bars in the over cladding and twin skin options above. This system uses a basic bar and bracket design that is highly adjustable, allowing you to set the height anywhere from 100 mm up to 280 mm. The components are built with a sturdy 3.73 mm thickness and feature various pre-drilled holes, ranging from 5 mm to 11 mm, to make installation easier.



GRP ROOF LIGHTS

Glass Reinforced Plastic Roofing

Cardinal Steels helps you bring light into your building with GPR (Glass Reinforced Plastic) roof lights. The material is incredibly strong and durable, initially developed in the Second World War for planes, meeting safety standards and making it ideal for roofing.

Unlike many other materials, GRP can be moulded into almost any shape. This means our roof lights are incredibly versatile and are available with a box profile or corrugated profile, matching the form of our box profile roof sheets and corrugated roof sheets. We also have roof lights in other shapes, such as Big 6 (Big Six), which was generally the profile used for roofing made from asbestos.

GRP Roofing That Allows The Natural Light In

The roof lights are a fantastic alternative to having a complete steel roof, which blocks out all natural light. This often results in a building that feels cold and dark, requiring lots of electricity to illuminate the space.

Natural light floods your agricultural building, factory or warehouse with our GRP roof lights, reducing your electricity costs and reliance on artificial light. If you are looking to save money long-term or run a more sustainable operation, then GRP roof lights are an excellent choice.

Custom Made GRP Roof Lights

Our custom made glass-reinforced plastic roof lights are made to the highest standards and are available in lengths up to 6.1m long. They can be produced to precisely match the size of our insulated and steel roofing sheets.

Cardinal's roof lights are weatherproof, have high impact resistance and have a film layer applied to them to enhance UV protection. The protective film helps stop UV damage such as dis-colouring or yellowing and helps extend the product's life expectancy to its max.

AVAILABLE PROFILES

CS32/1000 BOX PROFILE – ROOF LIGHT

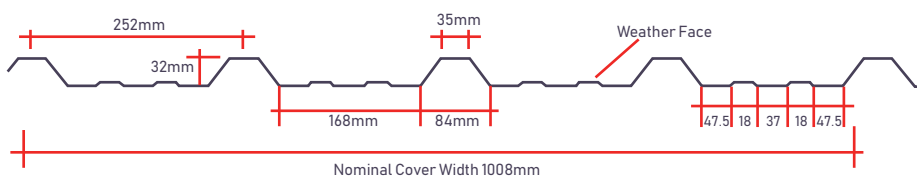

CS34/1000 BOX PROFILE - ROOF LIGHT

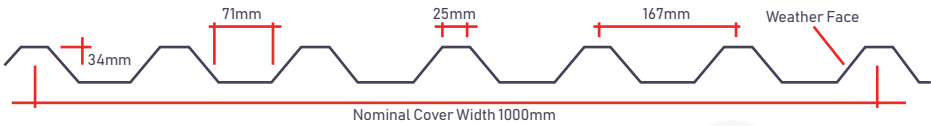

13.5 / 3 CORRUGATED - ROOF LIGHT

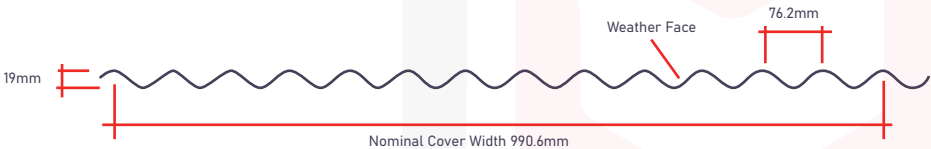

BIG 6 CORRUGATED - ROOF LIGHT

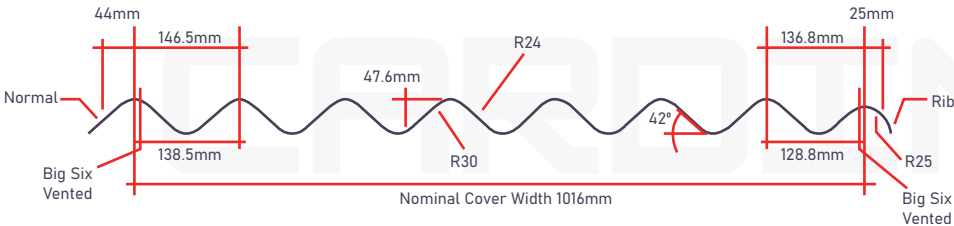

DOUBLE 6M CORRUGATED - ROOF LIGHT

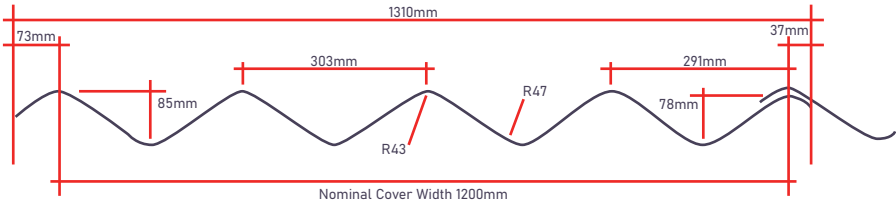

Z PURLINS AND SECTIONS

Cardinal Steels offer a selection of purlins available in the form of both Z purlins and C section. There are various thicknesses and depths. The thickness and depth are judged by the span that the purlin / section is covering combined with the weight capacity.

The Depths Of Purlins And Sections We Offer

- CS 121
- CS 140
- CS 177
- CS 200
- CS 235
- CS 265

Z PURLIN

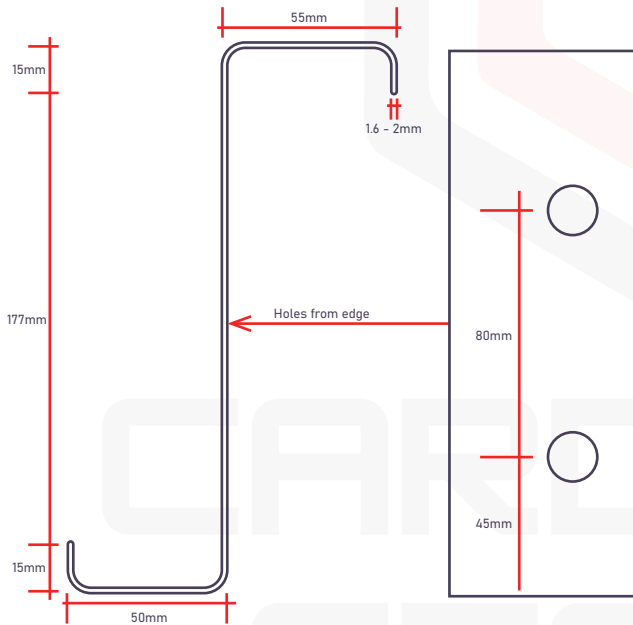

Available Thicknesses For Purlins And Sections

- 1.4mm
- 1.6mm
- 1.8mm
- 2.0mm
- 2.5mm

Z PURLINS AND SECTIONS IN STOCK

When contacting one of our members of staff, please use the figures and codes to specify your requirements, i.e. if you require a 177mm depth with a 1.6mm thickness please use code CS17716.

We offer Eaves Beams as standard 190mm deep with a 2.0mm thickness. These are available cut to length like all other items. Please use reference CS190230 when asking for quotations or purchasing.

We keep various lengths and depths of Z purlin and C section in stock. As standard up to 6.1m lengths and in 177mm and 200mm, ideal for use with our corrugated panels or box profile.

For more info on Z Purlins, C sections, Eaves Beams and all other accessories available from our range, please see our downloadable brochure with all relevant span and load tables.

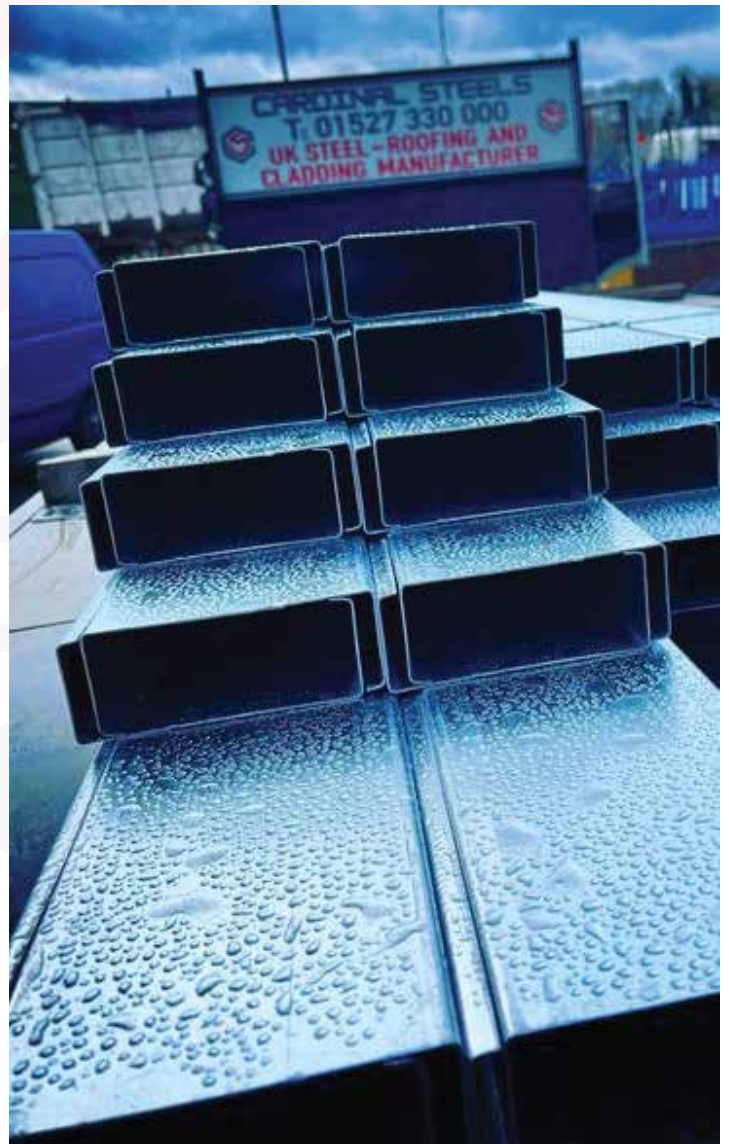
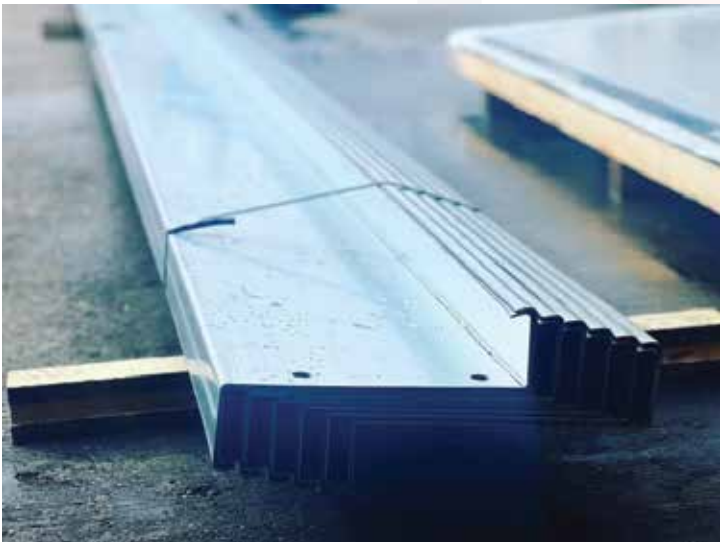

FLASHING AND TRIMS

Steel Roof Flashing And Trims

Steel flashing and trims are the final step and finishing touch in completing your roofing or cladding project. The steel trim and flashing act as weatherproofing for the corners and ends of the building, protecting it from damaging rainwater, snow, wind and ice. As standard, the metal cladding flashing is available in 3m lengths, but longer sizes are available on request.

You can order the metal edging trim at the same time as your corrugated or box profile roofing sheets and cladding to ensure consistent colour and a high quality finish. The steel roof flashing is quick and easy to fit, providing years of protection with no maintenance.

All materials, unless specified, come with welded edges, also known as safety edges, which help with handling during unloading and fitting. They also add rigidity to the products. If not welded, when fitting the flashing, it can cause the steel to have a wave look and edges to be sharp.

Most of our metal trims and flashings are manufactured for our Plastisol range due to the durability and excellent aesthetic of the finish. All flashings are available in polyester and galvanised as well.

An alternative to using standard plastic rainwater goods is our Trimline Gutter. This product can be manufactured in the same colour or an alternative. It gives a sharp, easy-on-the-eye finish to the building. Please ask a member of staff for details on this product as it can be manufactured to individual specification.

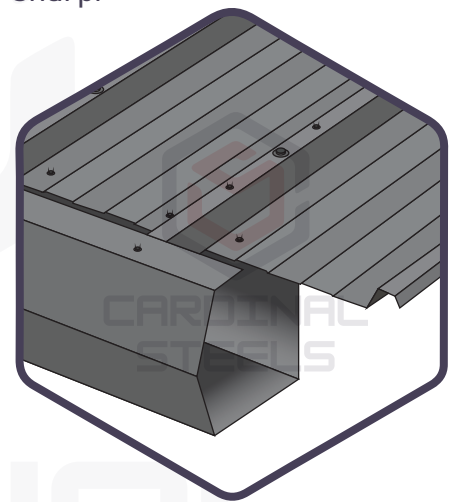

OUR FLASHING GUIDE

Each steel trim and flashing shape has a different purpose for your building. Cardinal Steels offers an entire range, including ridge, capping, gutter, corner, eaves and drip trims. Please see the diagram for clarification when quoting your products.

All steel flashings are manufactured to order and skillfully created with a quick turnaround by our experienced technicians using the latest manufacturing techniques. We also keep standard sizes in stock lengths for our complete colour range. They can be made to your specifications or our standard stock items include:

-  Ridge Cap - 200mm x 200mm x 3000mm long
-  Barge Board - 200mm x 200mm x 3000mm long
-  Barge Board - 150mm x 150mm x 3000mm long
-  Drip Cill / Head - 100mm x 50mm x 50mm x 20mm x 3000mm long

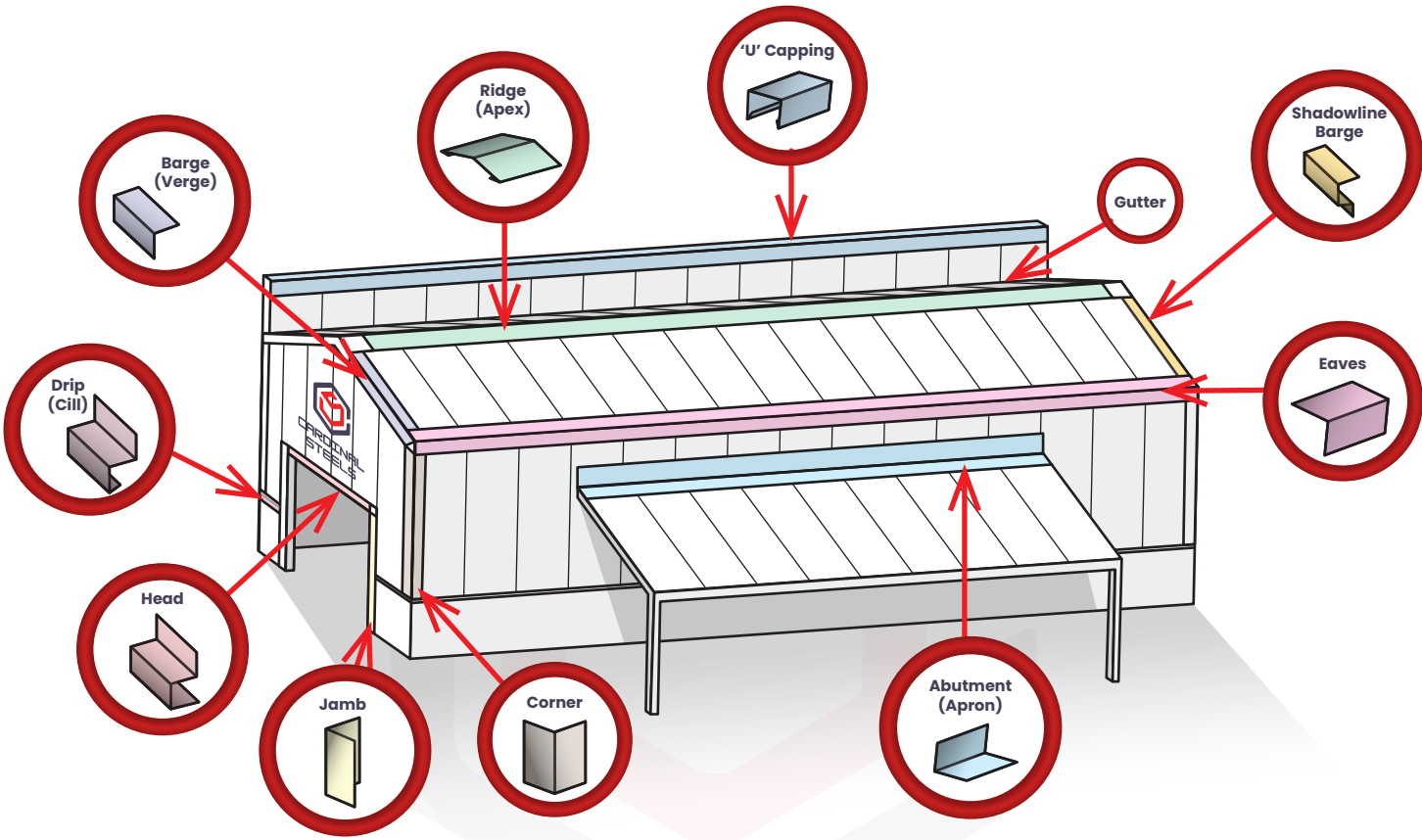

AVAILABLE COLOURS

Please be aware that these are colour representations to be used as a general guide and the physical colour may vary. Please get in touch with a member of our team if you would like a colour sample sent out to you.

WHITE	GOOSEWING GREY	MEADOWLAND	ALBATROSS
MERLIN GREY	MOORLAND GREEN	WEDGEWOOD BLUE	HERITAGE GREEN
OCEAN BLUE	ANTHRACITE	OLIVE GREEN	TERRACOTTA
SARGASSO	BLACK	JUNIPER GREEN	VANDYKE BROWN

ACCESSORIES

A One-stop-shop For Your Steel Roofing Fixings

Cardinal Steels offers a wide range of roofing accessories, from steel fixings and foam fillers, to insulation and Tek screws for corrugated roofing. Where magnetic bit Tek drivers are required for fitting, these are supplied as complimentary on request with all orders.

The fixings come in a variety of sizes and each type is distinctive and easily recognisable for their job. The cardinal range varies in length from 25mm up to 210mm in length.

Cardinal Steels is a one-stop-shop for all your steel roofing accessories. We supply everything you need to give your project a professional finish. Our roof sheet fixings include:

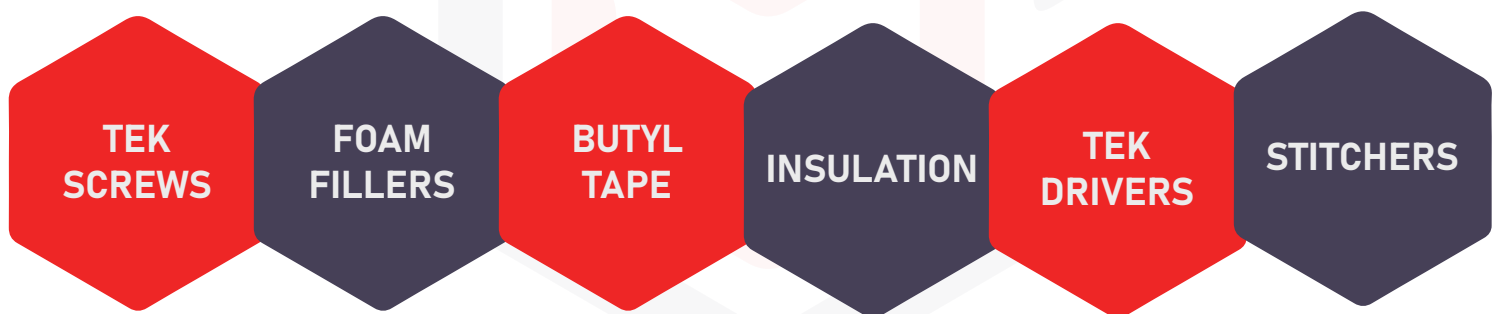



Tek Screws & Screw Caps

Our Tek screws have an 8mm hexagon head and are supplied with Tek screw caps that are colour-matched to your roofing material.





We provide a variety of sizes with different types for each roof beam material:

-  Wood Tekes - These roofing accessories fix the sheets to timber. They can be used for timber purlins and over-cladding when using timber rails. The wood Tekes are available in 32mm to 210mm lengths.
-  Light Metal Tekes - These roof fixings are generally used for cold-rolled rails and Z / C purlins from 1mm up to 4mm thickness. They are available in lengths of 25mm to 210mm.
-  Heavy Metal Tekes - These metal fixings are used for heavy-duty steel, such as hot rolled sections from 4mm up to 12mm thickness. We supply 32mm to 210mm lengths.

Foam Fillers

While the profiling roofing sheets create a structurally solid and stable roof, the profile creates gaps between the flashings and eaves of the building. Precision manufactured foam fillers close these gaps to create a weather-tight seal and prevent issues such as:

-  Dust and dirt being blown into the building
-  Small birds and animals entering the building
-  Keeping the building weather tight

Vented foam fillers are also available for use alongside the anti-condensation lined sheets.



Butyl Tape

Butyl lapping tape is used to overlap the roofing sheets and where GRP roof lights are introduced into the design. Once used, this product creates a strong bond and solid finish, so make sure you are happy with the sheet positioning before applying. Rolls have a standard size of 9mm x 3mm in 15m rolls.



Insulation

Cardinal Steels uses several mainline insulation distributors. We keep 80mm and 100mm insulation in stock. Please ring a member of our staff to confirm how many meters are on each roll, as this can vary by supplier. The product can be used on single skin over clad systems or on built-up twin skin systems.



Tek Drivers

The drivers supplied by Cardinal have a magnetic bit to help whilst fitting. They are available for both standard fixings and moulded head fixings. Please ask a member of staff if needed and will be supplied complimentary with your order.



Stitchers

Sheet-to-sheet fixing is essential, and our roofing accessories include 22mm stitchers for this task. The stitchers are used for overlapping roofing sheets and for fixing flashings to the roofing sheet.

Moulded fixings

These are high-strength, self-drilling screws designed to fix metal sheets to timber or steel frames. They feature a durable plastic head that is color-matched to your cladding, providing a seamless finish without the need for separate screw caps. Each screw comes with a bonded rubber washer to create a permanent, watertight seal.

Dektites (Pipe Flashing)

Dektites are flexible, weather-proof "boots" used to seal pipes or flues where they exit through your roof. Made from high-quality rubber or silicone, they easily mold to the profile of your roof sheets. They provide a long-lasting, leak-proof barrier that handles extreme temperatures and the natural movement of the building.

Silicone Sealant

Professional-grade silicone is specifically designed for roofing and cladding applications. Being "neutral cure," it won't react with or corrode metal surfaces, while its "low modulus" properties ensure it stays highly flexible—allowing it to stretch and move with your building without cracking. It is available in a variety of colors, including Clear, Black, Grey, White, Anthracite, and Alusilver, to match your project perfectly.

Installation extras

Installation extras are available on request. These can include the following (if required):

-  Tin Snips
-  Gloves
-  Applicator Gun (for sealant)

CARDINAL
STEELS

REVIEWS

Check out some of our latest Google Reviews from customers:

"I ordered some various sizes in the plastisol finish for my summer house and the service was second to none. From the first phone call to the delivery driver the whole experience was excellent and not to mention the product itself was also great and at a competitive price I highly recommend these guys to anyone around the country they drove over 2 hours to get to me in Hertfordshire bang on all round well done and thank you to everyone at Cardinal ★★★★★👍👍"

Giuseppe Molinaro
★★★★★

"Friendly fast and efficient and really cost effective. This the second time I've used them and I get the same level of attention for my small jobs as I would for larger ones. Will definitely use them again."

Peter Baker
★★★★★

"Couldn't recommend enough! We use Cardinal Steels regularly and they are always spot on. Great quality materials, reliable lead times, and a really helpful team. Orders are always accurate and on time, which makes a big difference when you're working to tight schedules. Would definitely recommend and will continue using them. Cheers from the TCR team 👍"

The Brand
★★★★★

"Had our new roof delivered today. Can't recommend the company enough. Great communication, good price and went out their way to delivery quickly for us. Delivery driver was polite, friendly and helpful. Lovely company, thank you 😊"

Caitlin Howell
★★★★★

"A knowledgeable, helpful and friendly team, and a great service as well. Thanks!"

Clive Stringer
★★★★★

ROOFING CALCULATOR

Scan The QR Code For
Our Online Roofing
Calculator



CONTACT US

Our Office

22 Aston Road
Bromsgrove
Worcestershire
B60 3EX

Open Hours

Monday to Thursday : 8am till 5pm

Friday: 6am till 2pm

Saturday: By appointment only

Sunday: Closed

Get In Touch

sales@cardinalsteels.com

01527 33 00 00

FIND US





cardinalsteels.com